



Savi 8210/8220 Office

Wireless DECT headset system for
computer, desk phone and mobile

User Guide

Contents

DECT Information	3
DECT Enhanced Security	3
Overview	4
Base and Headset Basics	4
Accessories	5
Hook up system	6
Desk phone setup details	6
Position Your Base	7
Fit and charge	9
Customize Your Headset	9
Charge Your Headset	9
Talk Time	9
Headset battery status	9
Load software	10
Update your Poly device	10
Pair your headset	11
Auto connect feature	11
The basics	12
Headset Controls	12
Power on your headset	12
Make, answer, end calls	12
Adjust volume	13
Mute	13
Interact with Microsoft softphone	13
Change your default phone line	13
Get a dial tone	13
Transfer mobile audio	13
Audio streaming	13
ANC	13
Limit office noise	13
Mini conference call	13
Set up a conference call	14
More Features	15
Change voice prompt language	15
Optimize audio quality	15
Base Subscription Button	15
Troubleshooting	17
Headset	17
Desk Phone	18
Mobile	18
Softphone	18
What's in the box	20
Support	21

DECT Information

DECT products should never be used outside the region in which they were originally purchased and intended to be used.

The enclosed DECT 6.0 wireless product uses restricted wireless radio frequencies which vary by country. DECT 6.0 devices are generally authorized for use in the US/Canada/Mexico. Use of this DECT 6.0 product in unauthorized countries is a violation of law, may disrupt telecommunications networks and devices, and can subject you to fines and penalties by regulatory agencies.

DECT Enhanced Security

Poly is a member of the DECT Forum and has fully adopted their recommendations for enhancements to security within all DECT products.

Poly DECT-based products now fully incorporate the latest recommendations on Enhanced Security from the DECT Forum and ETSI. These improvements cover registration, authentication, authorization and encryption procedures. Poly DECT products are now secure against known vulnerabilities that were highlighted by the public announcements of the Chaos Communication Congress in 2009.

Poly DECT products have been tested against and passed the DECT Forum security certification requirements and consequently have been granted 'DECT Forum security' logo certification.

Poly DECT products using the new enhanced version of DECT that includes these security improvements are marked on the base with the DECT Forum security logo.



Overview

Base and Headset Basics

Base

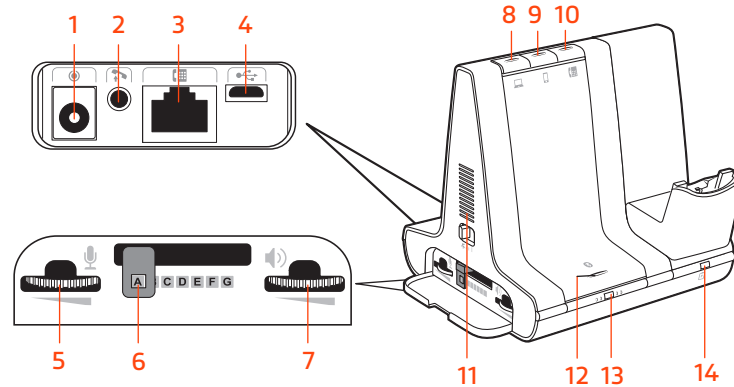

- 1 Power jack
- 2 Handset lifter jack
- 3 Telephone interface cable jack
- 4 USB port
- 5 Desk phone speaking volume
- 6 Desk phone configuration switch
- 7 Desk phone listening volume

- 8 Computer button
- 9 Mobile phone button
- 10 Desk phone button
- 11 Incoming call ringer
- 12 Bluetooth pairing button/LED
- 13 Subscription button/LED
- 14 Charging LED

Headset



- 1 Volume wheel
- 2 Call button/Press to interact with Microsoft Teams (app required)
- 3 Mute

- 4 Headset LED
- 5 Power button
- 6 ANC (Active Noise Canceling)

Be safe

Please read the safety guide for important safety, charging, battery and regulatory information before using your new headset.

Accessories

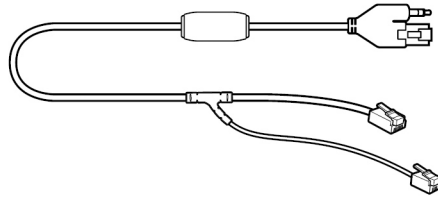

1

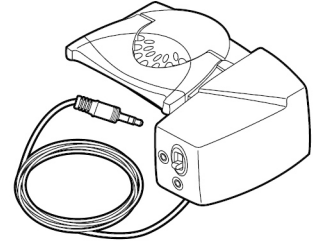

2

1 Electronic hookswitch cable (EHS cable) Electronically and automatically answers/ends a desk phone call. Enables remote call control with your headset.

2 HL10 lifter Automatically lifts handset and returns it to the cradle. Enables remote call control with your headset.

Hook up system

Using the diagram, connect your headset system.

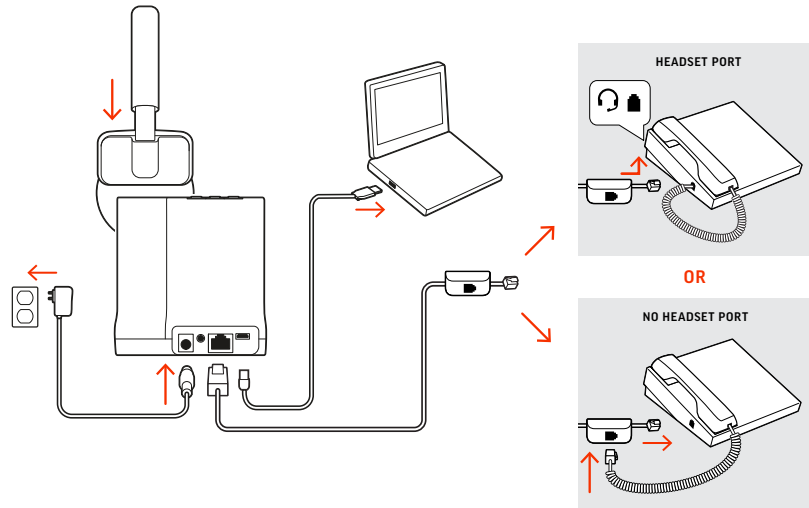

NOTE Base configuration settings

Desk phone	Setting (on base's side panel)
Most phones	A
Cisco phones	D
Cisco phones with EHS cable	A

Desk phone setup details

Choose a desk phone setup **A**, **B**, **C** or **D** and connect cables.

A Desk phone with dedicated headset port

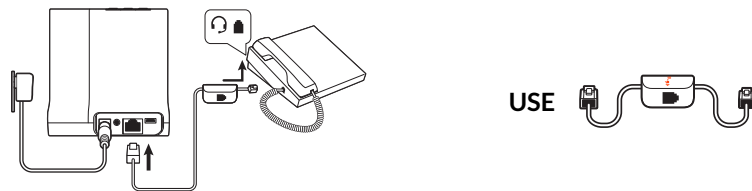

- Connect one end of the telephone interface cable to the back of the base
- Connect the other end of the telephone interface cable into the dedicated headset port on the desk phone

IMPORTANT Cisco phones use configuration **D** on the side of the base. Most other phones use default configuration **A**.

NOTE Use this setup if you are not using the HL10 lifter or EHS cable. In this configuration, press both the headset button on your desk phone and the call control button on the headset to answer or end calls.

B Desk phone (standard)

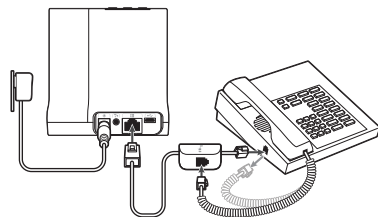

- Connect one end of the telephone interface cable to the back of the base
- Disconnect the handset coil cord from the base of the desk phone and re-connect it to the telephone interface cable junction box
- Finally connect the remaining end of the telephone interface cable into the open handset port on the desk phone

IMPORTANT Cisco phones use configuration D on the side of the base. Most other phones use default configuration A.

NOTE Use this setup if you are not using the HL10 lifter or EHS cable and your desk phone does not have a dedicated headset port. In this configuration, manually remove the handset on your desk phone and press the call control button on the headset to answer or end calls.

C Desk phone + EHS cable (sold separately)

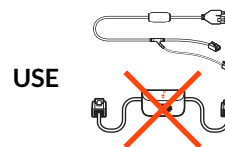
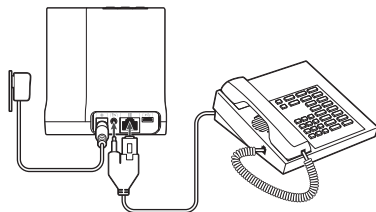

IMPORTANT Use configuration A on the side of the base, which works for most phones including Cisco phones.

D Desk phone + HL10 lifter (sold separately)

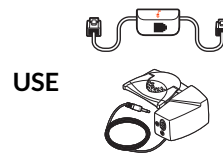
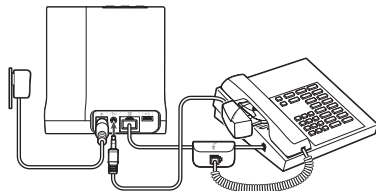

IMPORTANT Cisco phones use configuration D on the side of the base. Most other phones use default configuration A.

Position Your Base

The minimum recommended separation between your desk phone and the base is 6 inches.

The minimum recommended separation between the base and computer is 12 inches. Incorrect position can cause noise and interference problems.

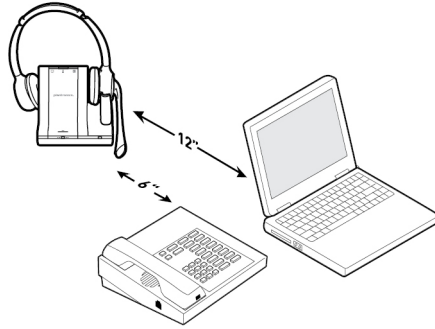

Fit and charge

Customize Your Headset

Optimize the comfort and fit of your headset.

Adjust the Headband

- 1 To adjust the headband, lengthen or shorten the band until it fits comfortably. Position the earcups so that the foam cushions sit comfortably over the center of your ears.



- 2 Position the stabilizer T-bar above your ear, if applicable.

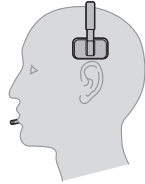

Adjust the Boom

For optimum audio, bend the boom so it is approximately two finger widths from the corner of your mouth.



NOTE For true stereo listening when wearing the boom on the left, adjust the wearing preference setting in Poly Lens Desktop App.

Charge Your Headset

Place the headset in the charge cradle. The headset charging LED flashes green when charging the headset and turns solid green when the headset is fully charged. Charge for at least 20 minutes prior to the first use. A full charge takes 3 hours.

Talk Time

With a single full charge, the headset provides up to 13 hours of continual talk time in wideband mode.

Headset battery status

Determine your headset battery status:

- Listen to the voice prompts after powering on the headset
- Press the base subscription button; the base Audio buttons light up (solid green is high battery, flashing green is medium, flashing yellow is low, flashing red is critical).
- View in Poly Lens Desktop App

Load software

Customize your device behavior through advanced settings and options with Poly Lens Desktop App. Some softphones require the installation of Poly software to enable device call control (answer/end and mute) functionality. Download: poly.com/lens.

NOTE *Device settings are also available in Plantronics Hub Desktop App.*

Update your Poly device

Keep your firmware and software up-to-date to improve performance and add new features to your Poly device.

Update your device using Poly Lens App. Download at poly.com/lens.

Pair your headset

- 1 To pair your base and mobile phone, first power on your headset. Press and hold the Bluetooth pairing button on the base for 4 seconds until the Bluetooth LED flashes red and blue.

NOTE Your base and headset are automatically paired/subscribed.

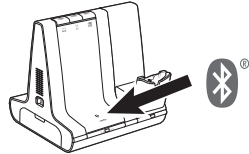

- 2 Go to Bluetooth settings on your mobile phone and select Poly Savi. Once successfully paired, the Bluetooth LED on the base turns solid blue.

Auto connect feature

Once you have paired and connected your mobile phone to the base, the base automatically connects to it when you are in range of your base.

To manually disconnect/connect your mobile phone from the base, press the base Bluetooth button.

Customize feature in Poly Lens Desktop App.

The basics

Headset Controls

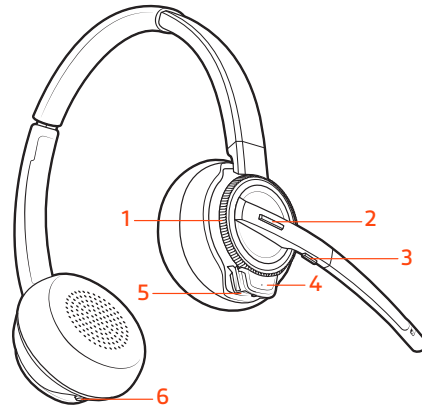

- 1Volume wheel** Toggle repeatedly forward or backward to adjust volume
- 2Call / Teams button** Press to place, answer, end a call or to interact with Microsoft Teams (app required)
- 3Mute button** During a call, press to mute and unmute
- 4Headset LED** Flashes when in use
- 5Power button** Toggle on and off
- 6ANC (Active Noise Canceling)** Toggle on and off



Power on your headset

To turn on the headset, slide the Power button on the bottom of the earcup to reveal green.

Make, answer, end calls

On the top of the base there are three Audio buttons: computer, mobile, desk phone. These buttons allow you to switch to a different phone line/audio channel.

Make a call

- 1 Tap an Audio button    on the base.
- 2 *Deskphone only:* Manually remove the handset if you don't have an HL10 lifter or EHS cable. You should hear a dial tone.
TIP If you do not hear a dial tone, open the base side panel and adjust the middle switch (A--G). "A" works for the majority of desk phones.
- 3 Dial from your softphone/mobile phone/desk phone.

Answer/end a call

To answer or end a call, tap the Audio button    on the base or tap the headset Call button.

TIP Headset call control for the computer requires Poly software and softphone compatibility. See "Download software."

Answer a second call

- 1 While on a call, press the headset Call button for 2 seconds to answer the second call. This will place the first call on hold.
- 2 To switch between the calls, press the headset Call button for 2 seconds.

Reject a Mobile Call

To reject an incoming call, hold the base mobile button down for 3 seconds.



Adjust volume

- **Headset volume** Toggle the volume wheel repeatedly forward or backward to adjust volume.
- **Desk phone volume** When you are on a desk phone call and your voice is too quiet/loud, adjust the microphone volume on the side of the base, located behind the access panel. If your caller's voice is too loud/quiet on a desk phone call, adjust the base volume dial.
- **Base ringtone volume** Adjust the base ringtone volume on the left side of the base. This ringtone alerts you if you are not wearing your headset and a call comes in. There are 4 base ringer settings: off, low, medium and high.

Mute

To mute your headset during on a call, press the headset Mute button. When mute is active, the base button is red. To unmute, press the headset Call button or the active base Audio button.

Interact with Microsoft softphone

- For Microsoft Teams, tap the headset's Call  button to interact (Teams desktop application required).
- For Skype for Business, press and hold the headset's Call  button for 2 seconds to interact (Skype for Business desktop application required).
- Set your target phone in Poly Lens Desktop App.

Change your default phone line

With the system idle, change your default phone line/audio channel by pressing and holding for 4 seconds the desired base Audio button until it flashes green 4 times. *Customize in Poly Lens Desktop App.*

Get a dial tone

To open an audio channel or get a dial tone, press the headset Call button for 1 second while the system is idle; the default base Audio button turns green.

Transfer mobile audio

When you answer a call, the audio stays with that device (if you answer with the headset, the audio stays on the headset; answer with your mobile phone, the audio stays on your mobile).

- 1 To transfer a mobile call **from your headset to your mobile phone**, press the base mobile phone button for 3 seconds. The green LED turns off.
- 2 To transfer a mobile call **from your mobile phone to your headset**, press the base mobile phone once. The green LED turns on.

Audio streaming

To stream audio from your computer or mobile device, first press the computer or mobile base Audio button and then play the audio. When streaming audio, the base Bluetooth button is purple.

ANC

Active Noise Canceling (ANC) reduces external noise and enhances your music and sound quality.

Your headset ships with ANC on. To turn ANC off, slide the switch away from "ANC."

Limit office noise

You can limit the amount of nearby conversation that is transmitted during your calls. *Customize feature in Poly Lens Desktop App.*

Mini conference call

Simultaneously hold the base buttons of any two of the three base buttons until the LEDs become solid green to combine the audio of any two devices and create a mini conference call.

Set up a conference call

You can set up a conference call with 3 additional headsets.

Join Savi headsets automatically

- 1 While on a call, place the guest headset into the primary user's charge cradle. The base subscription LED flashes green.
- 2 The primary user will hear a request "Conference requested." To accept the request, press the primary user's headset Call button. The base subscription LED turns solid yellow to indicate conference call mode. View conference call status in Poly Lens Desktop App.

Join Savi headsets manually

- 1 While on a call, press the base subscription button. The base subscription LED flashes yellow and green.
- 2 On guest headset, press and hold the Volume up button or turn the Volume wheel up until the headset LED lights up. Method varies by model.
- 3 The primary user will hear "Conference requested." To accept the request, press the primary user's headset Call button. The base subscription LED turns solid yellow to indicate conference call mode. View conference call status in Poly Lens Desktop App.

Exit a conference call

- 1 Guest headsets can remain as guests through multiple calls. To remove a guest headset, either press the guest headset's Call button or dock the primary user's headset in the charge cradle.

More Features

Change voice prompt language

Change the voice prompt language on your headset in Poly Lens Desktop App.

Optimize audio quality

There are 3 audio modes: wideband stereo (default), wideband (high quality telephony) and multimedia (high quality listening).

To optimize your audio quality for your activity, with the system idle, press the headset Mute button for 4 seconds. The base cycles through the modes with each 4 second press. The base blinks yellow for wideband stereo, green for wideband and red for multimedia mode.

Base Subscription Button

The headset and base that came in the box are subscribed (connected) to each other. However, if you wish to use a new headset or need to restore subscription to your current headset (base subscription button is red), the units can be subscribed to each other by the following methods.

The subscription button is below the Bluetooth button on the front of the base.

Base Subscription Button LED

Base Subscription LED	Base Status
Flashes green and red	Primary headset subscription mode
Solid green	Primary headset subscribed to base
Solid yellow	Active conference call with guest headsets
Solid red	No headset subscribed
Flashes green 3X, the yellow 2X	Security level changed from enhanced to standard

Set the range

Changing the range can help with PC audio quality, improve user density or restrict range of users.

You can adjust the range setting in Poly Lens Desktop App.

Setting	Range
High (Default)	up to 300 ft.
Medium	up to 150 ft.
Low	up to 50 ft.

Automatic secure subscription

With your system idle, docking a new headset automatically subscribes it to the base, making it the primary headset. The base subscription LED blinks green/red during subscription mode and remains green when the new subscription is established.

Manual secure subscription

With your system idle and your headset docked, double press the subscription button on the base. The subscription light will flash red and green. When the subscription light on the base becomes solid green, the headset and base are subscribed to one another.

Manual over-the-air subscription

- 1 With your system idle and your headset undocked, double press the subscription button on the base. The subscription light will flash green and red.
- 2 Put your headset in subscription mode by holding Volume wheel up for 4 seconds. Upon release, you hear "pairing" and the headset LED flashes red/green. When the subscription light on the base remains solid green, the headset and base are subscribed to one another; you hear "pairing successful. Base connected."

NOTE *If the base subscription LED goes solid red, after flashing red/green, the subscription attempt has failed and should be repeated.*

End Subscription

If the base is in subscription mode and you want to stop the base from searching for a headset, press the subscription button again. The subscription light will be solid red for four seconds and then go to its previous state.

Disabling over-the-air subscription

The Savi system ships with the over-the-air headset subscription enabled. In a multi-shift environment, you may want to disable this mode of subscription.

To disable over-the air subscription, while your system is idle, hold the subscription button and the base computer button down simultaneously until the base computer button LED flashes (green for enabled, red for disabled).

Manage settings in Poly Lens Desktop App.

Troubleshooting

Headset

I can't hear a dial tone in the headset.

- Make sure your headset is charged.
- Make sure your headset is subscribed to base. See [Subscribe headset to base](#).
- Adjust the configuration switch (A–G) on the side of the base until a dial tone is heard. The default **A** works for most phones.
ATTENTION Use configuration **D** for Cisco phones. Cisco phones connected with EHS cable use configuration **A**.
- Make sure your desk phone is connected correctly to your base. See [Desk phone setup details](#).
- If your base is connected to your desk phone's dedicated headset port, press the desk phone's headset button to hear a dial tone.
- If your base is connected to your desk phone's dedicated headset port, press the desk phone's headset button and base's desk phone button to hear a dial tone.
- If your base is connected to your handset port, manually remove the handset to hear a dial tone (if you do not have an EHS cable or HL10 lifter).
- Make sure your HL10 lifter is lifting the handset high enough to operate the hookswitch; set to a higher setting if necessary.
- Adjust the headset's listening volume. See [Adjust volume](#).
- If the volume is still too low, adjust the desk phone listening volume on the base. See [Adjust volume](#).

I hear static.

- Make sure there is at least 12 inches between your base and your computer, and 6 inches between your base and your telephone. If adjusting the distance doesn't help, your headset is going out of range, move closer to the base. See [Position Your Base](#).

The sound is distorted.

- Lower the desk phone speaking volume and/or desk phone listening volume on the base. For most telephones the correct setting is position 2. See [Adjust volume](#).
- If your desk phone has a volume control, lower until the distortion disappears.
- If the distortion is still present, adjust the headset volume control to lower the headset speaker volume. See [Adjust volume](#).
- Make sure there is 12 inches between your base and your computer, and 6 inches between your base and your telephone. See [Position Your Base](#).

I hear echo in the headset.

- Lower the desk phone speaking volume and/or desk phone listening volume on the base. For most telephones the correct setting is position 2. See [Adjust volume](#).

- If the audio level is too low in this position, increase the headset volume. See [Adjust volume](#).
- If your speaking volume is too low for your listener in this position, adjust the position of the headset to make sure the microphone is as close as possible to your mouth.

People I talk to can hear a buzz in the background.

- Move the base further away from your phone. See [Position Your Base](#).
- If the base power supply is plugged into a power strip, plug it into the wall directly.

Desk Phone

The handset lifter is installed but does not lift the handset.

Be sure the handset lifter power cord is firmly pushed into the handset lifter jack on the base.

When I use an EHS cable with a Poly VVX phone and I answer a call with my headset, the call fails.

This is a known issue. Press one of the base audio buttons (computer/mobile/desk phone) to answer the incoming call.

Mobile

Pairing problems

Ensure the Bluetooth LED on the base flashes red and blue by pressing the Bluetooth button for four seconds.
Ensure the Bluetooth mobile phone is in search mode.
When an active Bluetooth connection has been made, the base Bluetooth LED is solid blue.

Why doesn't the base automatically reconnect with my mobile phone?

Ensure Poly Lens Desktop App has been installed.
Adjust the "Auto-connect to mobile phone" in Poly Lens Desktop App.

Softphone

When I use an EHS cable with a Poly VVX phone and I answer a call with my headset, the call fails.

This is a known issue. Press one of the base audio buttons (computer/mobile/desk phone) to answer the incoming call.

When I dial from my softphone application, nothing happens.

Ensure your headset is charged.
Ensure your headset is subscribed to the base. See [Subscribing a Headset](#).
Ensure that the Poly software is installed. To download, visit poly.com/software.
Ensure that you are using a compatible softphone application. For a list of compatible softphones, visit poly.com/software.
If the Poly software is not installed and you do not have a compatible softphone, you must first press the base computer call button and then use the softphone interface to place/answer/end calls.
Ensure that the headset is the default sound device by going to your Sound Control Panel (Windows) or your Sound System Preferences (Mac).
Restart your computer.

How do I interact with Microsoft Teams or Skype for Business?

- For Microsoft Teams, tap the headset's Call \ button to interact (app required).
- For Skype for Business, press and hold the headset's Call \ button for 2 seconds to interact (app required).
- Set your target phone by going to Poly Lens Desktop App.

Does my Microsoft Teams-enabled headset work with other softphones?

Yes, while your headset is optimized for Microsoft Teams, it can be configured to use with other supported softphones. Set your target phone by going to Poly Lens Desktop App. When you configure another softphone, the Call button doesn't interact with Microsoft Teams.

Speaking and/or listening volume is too low or too high.

Adjust headset listening volume with volume button.
Adjust listening/speaking volumes in the computer's sound control panel/system preferences.
Adjust listening/speaking volumes in the softphone application.

The sound is distorted or I hear an echo in the headset.

Reduce speaking and/or listening volume on the computer using your softphone application.
Point microphone towards your chin.
If the distortion is still present, lower the volume on the headset.

I can no longer hear any audio through my PC Speakers.

For Windows XP systems

- Go to Start > Control Panel > Sounds and Audio Devices > Audio > Sound Playback and change the default setting from your Savi headset to your PC speakers. Click "OK" to confirm your change.

For Windows Vista and Windows 7 systems

- Go to Start > Control Panel > Sounds > Playback and change the default setting from your Savi headset to your PC speakers. Click "OK" to confirm your change.

For Mac OS X

- Choose Apple menu > System Preferences and click Sound.
- Click Output, and then select "Internal Speakers" or your speaker choice.

No audio connection to PC.

Unplug USB and power cables from base. Reconnect power cable first. Wait for power LED to illuminate, then re-connect USB cable. Quit and then re-start your PC audio or softphone application.

What's in the box

Contents may vary by product.



Headset

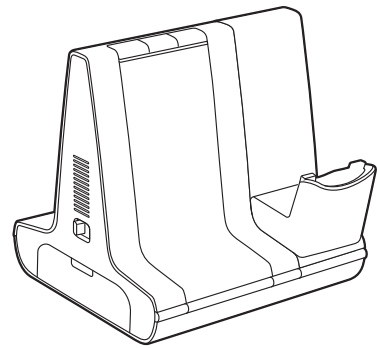

Base

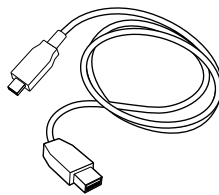

USB cables (2 included): Micro USB to USB-A, USB-C to USB-A



Telephone interface cable

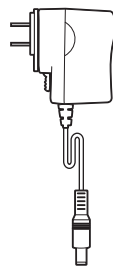

Power supply and plug adapters

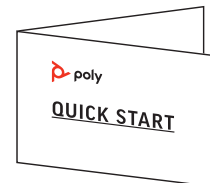

Quick start guide

Support

NEED MORE HELP?

poly.com/support

Manufacturer:

Plantronics, Inc.
345 Encinal Street
Santa Cruz, CA 95060
United States

Plantronics B.V.
Scorpius 171
2132 LR Hoofddorp
Netherlands

Plantronics Ltd.
Building 4, Foundation Park
Cannon Lane, Part 1st Floor
Maidenhead, SL6 3UD
United Kingdom

© 2021 Poly. Bluetooth is a registered trademark of Bluetooth SIG, Inc. All trademarks are the property of their respective owners. Manufactured by Plantronics, Inc.

Model ID: W8210/W8210-M (may be followed by /A or /S), W8220/W8220-M (may be followed by /A or /S), W8200B/W8200B1 (may be followed by /A or /S). System sentence: Savi 8210/8220 (-M) and Savi 8210/8220 Office (-M) have a W8200B/W8200B1 base (may be followed by /A or /S) and a W8210T/W8220T headset(may be followed by /A or /S).

212206-06 11.21